



SCOP		SEER			
Binnenunit	Type	AR45RIXH		Type	Unité intérieure
	Fabriekscode	ARXG45KHTB		Fabriekscode	
Buitenunit	Type	AO45RIX		Type	Unité extérieure
	Fabriekscode	AOHG45KBTB		Fabriekscode	
Koelmiddel		R32			Réfrigérant
Verwarming (*)	Vermogen (+7°C)	kW	13,5 (5,0~16,2)	kW	Puissance (+7°C)
	Electr.verm. (+7°C)	kW	3,61	kW	Puiss. absorb.nom (+7°C)
	COP (+7°C) / SCOP(°)		3,74 / n.v.t.		COP (+7°C) / SCOP(°)
	verm. max. bij -5°/-10°/-15°C	kW	14,0/12,73/11,46	kW	puiss. max. à -5°/-10°/-15°C
Koeling (*)	Vermogen	kW	12,1 (4,0~14,0)	kW	Puissance
	Electr.verm.	kW	4,16	kW	Puiss. absorb.nom
	EER / SEER (°)		2,91/n.v.t.		EER / SEER (°)
Pdesign	Verw. (Av.)(-10°C) / koelen	kW	n.v.t	kW	Chauff. (Av.)(-10°C) / refroid.
Jaarverbruik	Verw. (Av.) / koelen	kWh/jaar	n.v.t	kWh/an	Chauff. (Av.) / refroid.
Binnendeel	Debiet Q/L/M/H	m³/h	2430/2850/3350	m³/h	Débit Q/L/M/H
	Geluidsdruk Q/L/M/H (1m)	dB(A)	40/43/47	dB(A)	Niv. son. press. Q/L/M/H (1m)
	Werkgebied ext. stat. druk	Pa	100-250	Pa	Plage de fonct. Press. stat. ext.
	Ext. stat. druk fabreksinst.	Pa	100	Pa	Réglage d'usine press. stat. ext.
	Werkingslim. verwarmen	°C	16~30	°C	Plage de fonct. chauff.
	Werkingslim. koelen	°C	18~30	°C	Plage de fonct. refroid.
	Hoogte-breedte-lengte	mm	400-1050-500	mm	Hauteur/largeur/profond.
	Gewicht	kg	46	kg	Poids
Buitendeel	Geluidsdruk (1m)	dB(A)	57	dB(A)	Niv. son. press. (1m)
	Geluidsvermogen	dB(A)	71	dB(A)	Niv. son. puiss.
	Debiet	m³/h	4450	m³/h	Débit
	Compressor		DC Twin rotary		Compresseur
	Werkingslim. verwarmen	°C	-15~24	°C	Plage de fonct. chauff.
	Werkingslim. koelen	°C	-15~46	°C	Plage de fonct. refroid..
Hoogte-breedte-lengte	mm	998-940-320	mm	Hauteur/largeur/profond.	
Gewicht	kg	67	kg	Poids	
Elektr.install.	Voeding	V	230/1F	V	Alimentation
	Stroom max. verw./koel.	A	28,5-28,5	A	Amp. max chauff. / refroid.
	Zekering traag	A	32	A	Fusible retardé
	Hoofdvoeding aanbr.op		Buiten		Unité à alimenter
	Sectie voedingskabel	mm²	3G6	mm²	Section câble alimentation
Sectie tssn bi en bu	mm²	4G1,5	mm²	Section entre int. et ext.	
Tech.install.	Expansie		Ext.		Détente
	Koelleidingen	inch	5/8-3/8	inch	Lignes frigorifique
	Leidinglengte min-max	m	5-50	m	Longueur min / max
	Hoogteverschil max	m	30	m	Dénivelé max
Diam. condensafvoer bi/bu	mm	23,4/25,4	mm	Diam. évac. condensat int/ext	
Koelmiddel (**)	Koudemiddel		R32		Réfrigérant
	GWP-waarde		675		Valeur GWP
	Standaardvulling-afstand	kg-m	2,7-30	kg-m	Charge standard-distance
	CO ₂ eq. Standaardvulling	kg	1823	kg	CO ₂ eq. Charge standard
	Bijvulling extra	g/m	40	g/m	Charge supplémentaire
	CO ₂ eq. Bijvulling	kg/m	27	kg/m	CO ₂ -eq Charge supplémentaire
Bevat gefluoreerde broeikasgassen		Ja/Oui		Contient des gaz à effet de serre fluorés	
Hermetisch gesloten koelcircuit		Nee/Non		hermétiquement scellé	

(*) gegevens volgens de norm EN14511

(°) SCOP & SEER based on (EU)626/2011

(*) suivant la norme EN14511

(**) Europese verordening nr 517/2014 betreffende gefluoreerde broeikasgassen

(**)Le décret Européen n°517/2014 sur le gaz à effet de serre fluorés

Binnendeel	Unité intérieure
Unit: mm	

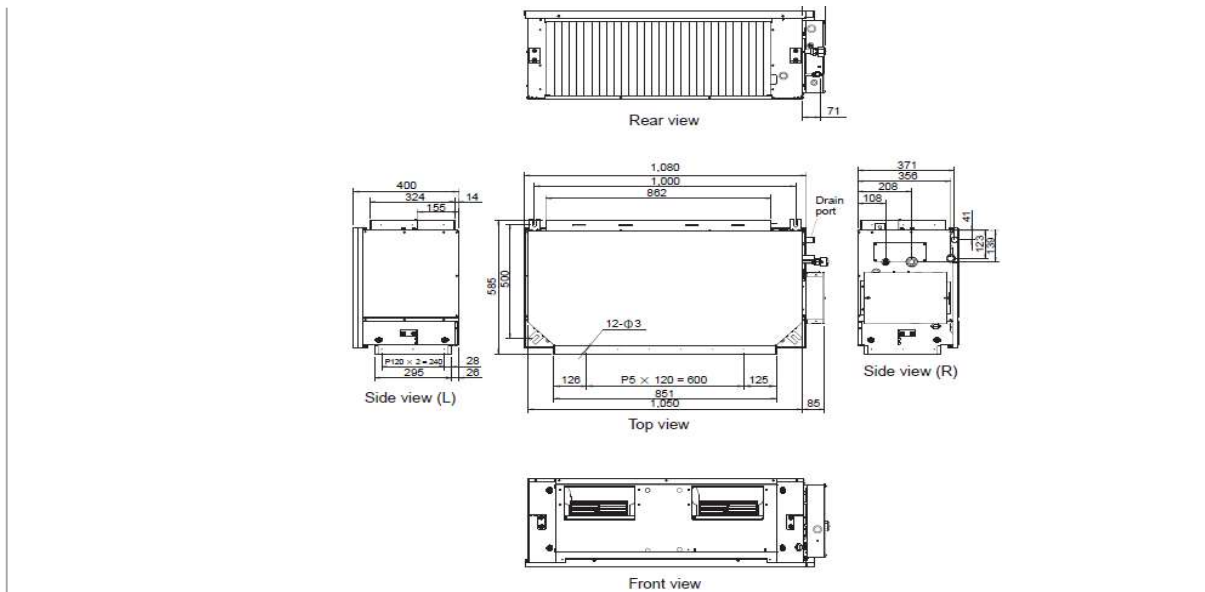

Buitendeel

Unité extérieure

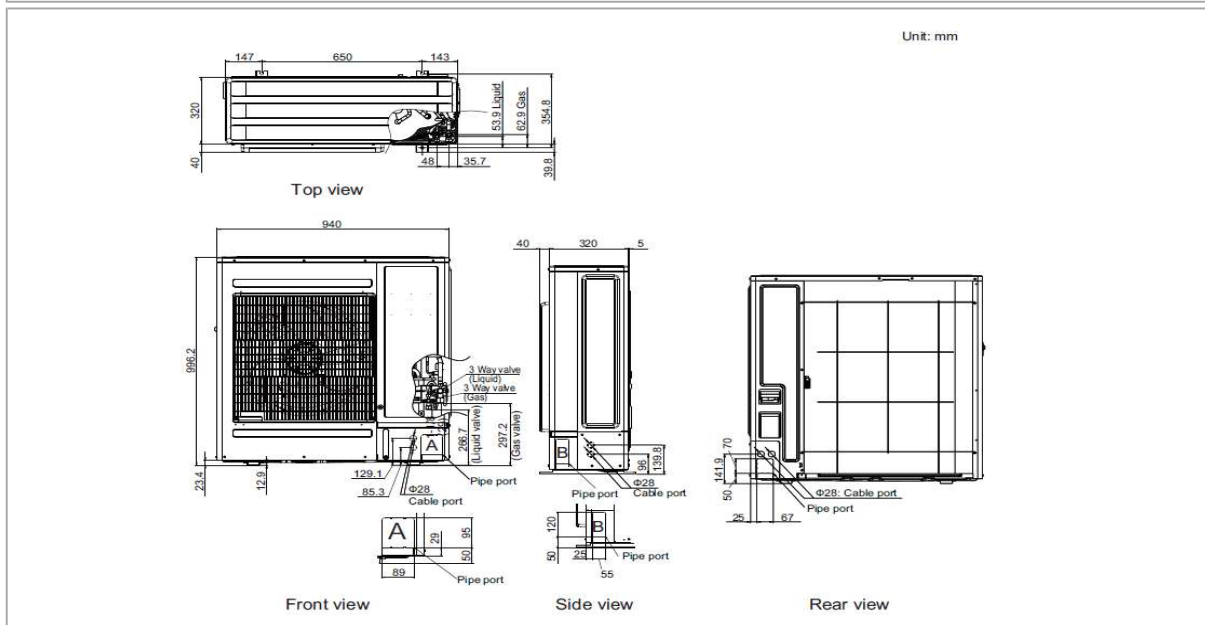

Technische fiche 3/6

Inbouw



AR45RIXH / AO45RIX

3/6 Fiche technique

Encastrable

Lucht

Air

Q-h Characteristic curve

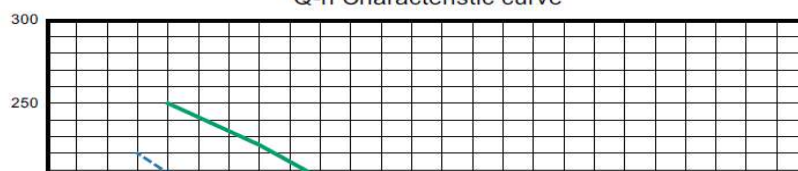

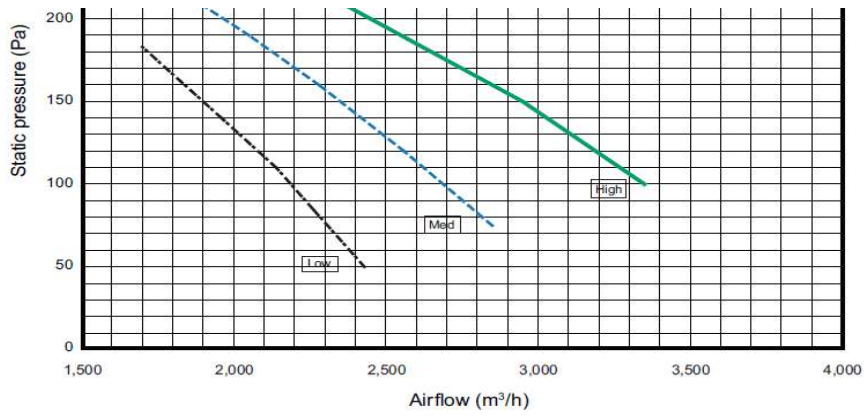

Plaatsing

Installation

Installation by which service space is made on top of the unit (recommended).

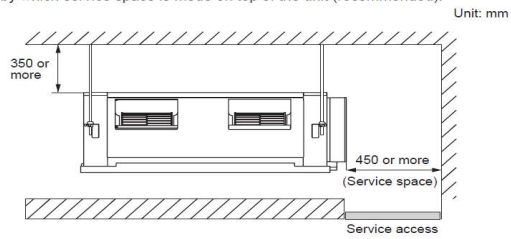

Installation by which service space is carried out from the bottom of the unit.

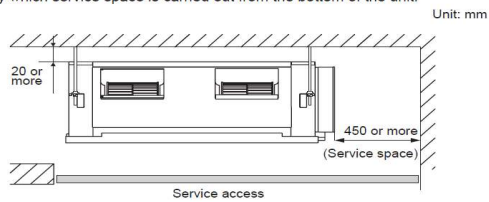

When there are obstacles at the rear only.

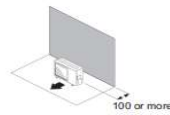

When there are obstacles at the rear and sides.

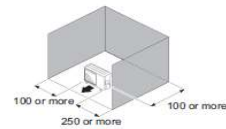

When there are obstacles at the front only.

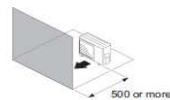

When there are obstacles at the front and rear.

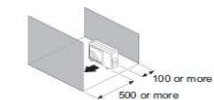

Technische fiche 4/6

GENERAL
AR45RIXH / AO45RIX

4/6 Fiche technique

Inbouw

Encastrable

Bediening

Commande

UTY-RVNGM



UTY-RRNGM

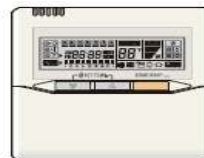

UTY-RSNGM





Technische fiche 5/6

Inbouw



5/6 Fiche technique

Encastrable

Inblaasplenum IBPL45H-54

TOEBEHOREN / ACCESSOIRES

Plénium de pulsion IBPLH45-54

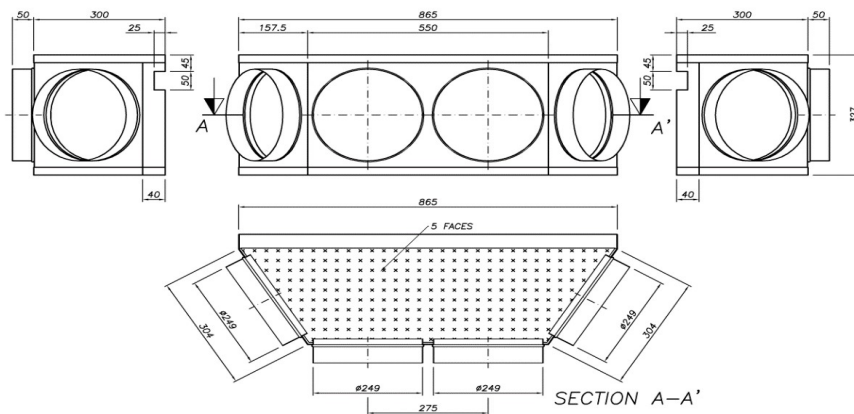

Retourplenum RP45H-54

TOEBEHOREN / ACCESSOIRES

Plénium de retour RP45H-54

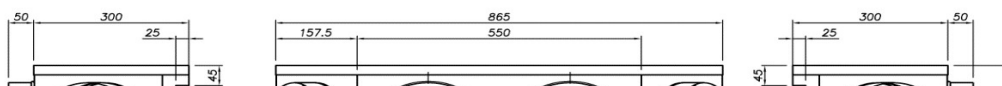

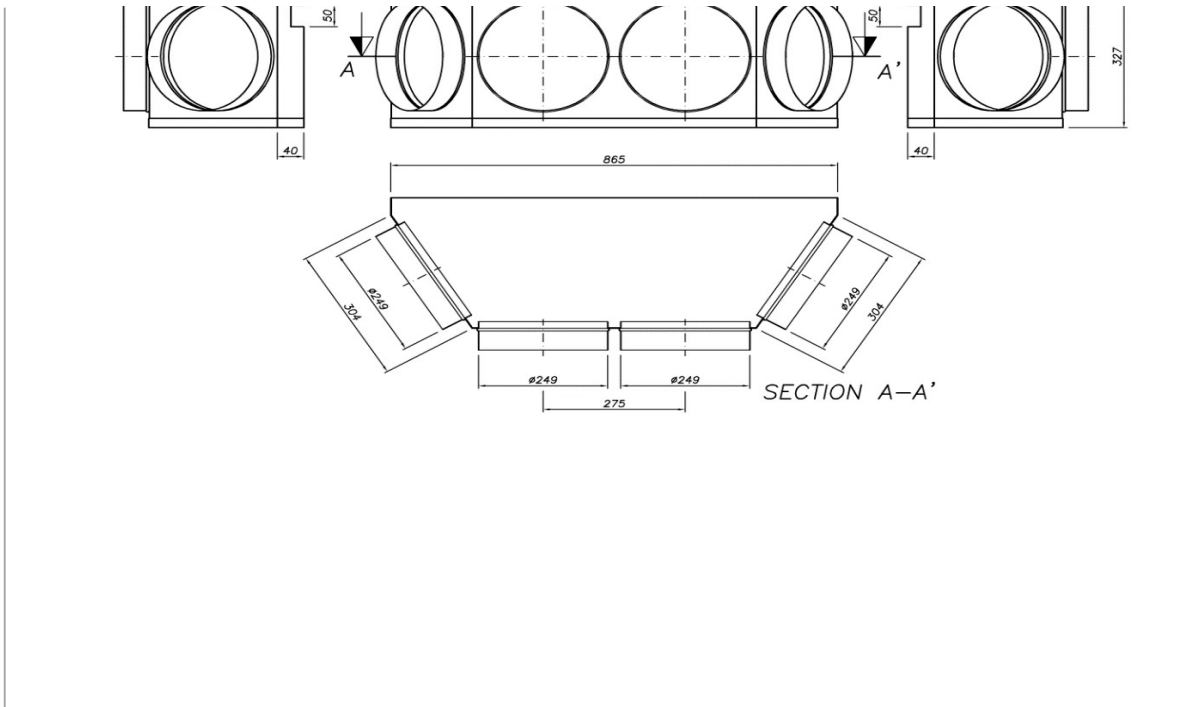

Technische fiche 6/6



6/6 Fiche technique

Inbouw

Encastrable

Retourframe (incl. filter) RFF45H-54

TOEBEHOREN / ACCESSOIRES

Cadre reprise air avec filtre RFF45H-54

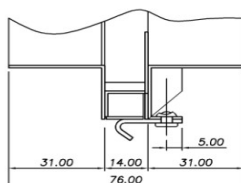
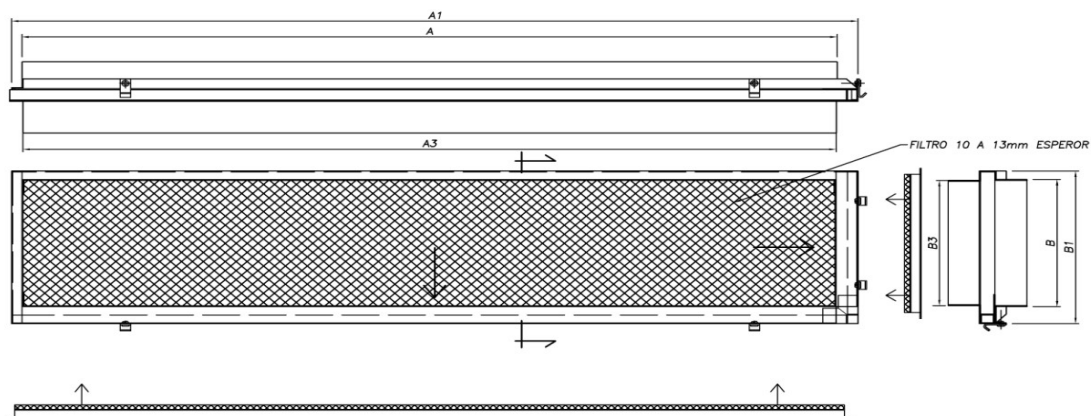

MODELO	FILTRO	A	A1	A3	B	B1	B3
AR-45-H-54-60	B74x334	865	892	862	327	355	324

